

more on page 739 and
weverducre.com/strex-custom

RECESSED EXAMPLES

configure your own STREX SYSTEM online at
weverducre.com/strex-configurator

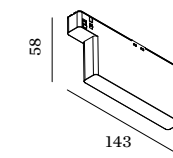
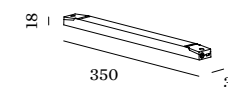
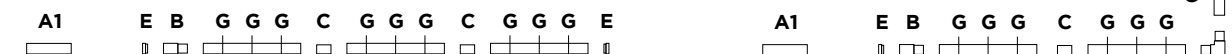

A1 | DRIVER

remote converter | 220-240VAC
50-60Hz | 48V | for connection to
power feed

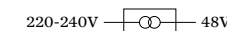

	CODE
100W 48V	90218901
150W 48V	90218902

for DALI SELV solution see page 740

F | WIRELESS CASAMBI CONTROL

8W | adapter for wireless control
of 64 fixtures in max. 8 groups

	CODE
	90014155
	90014156

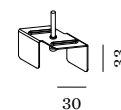
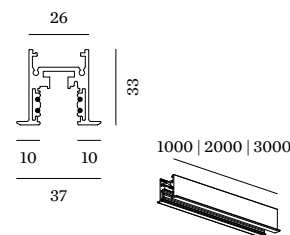

RECESSED

track 48V | 15A | DALI



	CODE
1m	90014187
1m	90014188
2m	90014189
2m	90014190
3m	90014191
3m	90014192

G | MOUNTING BRACKET

recessed mounting bracket

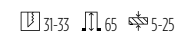

	CODE
	90014193

for 1.0m - 2pcs needed
for 2.0m - 4pcs needed
for 3.0m - 6pcs needed

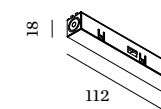

B | POWER FEED

48V | 15A | DALI | end/middle power
feed | max. 4 x 1.5mm²

	CODE
	90014153
	90014154

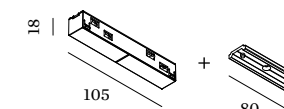

C | CONNECTOR

48V | 15A | DALI | electrical/
mechanical connector

	CODE
	90014196
	90014197

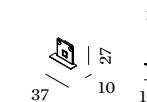

E | END CAP

	CODE
	90014149
	90014150

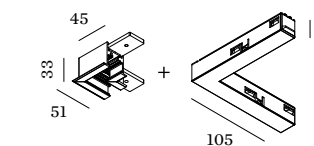

L | L-CONNECTOR

48V | 15A | DALI | electrical/
mechanical connector left and right

	CODE
	90014251
	90014252

for 4 corner O shape, refer to mounting
instructions or online configurator

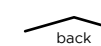

STREX SYSTEM

SURFACE | 48V DALI TRACKS

SURFACE EXAMPLES

configure your own STREX SYSTEM online at weverducre.com/strex-configurator

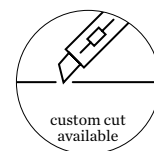
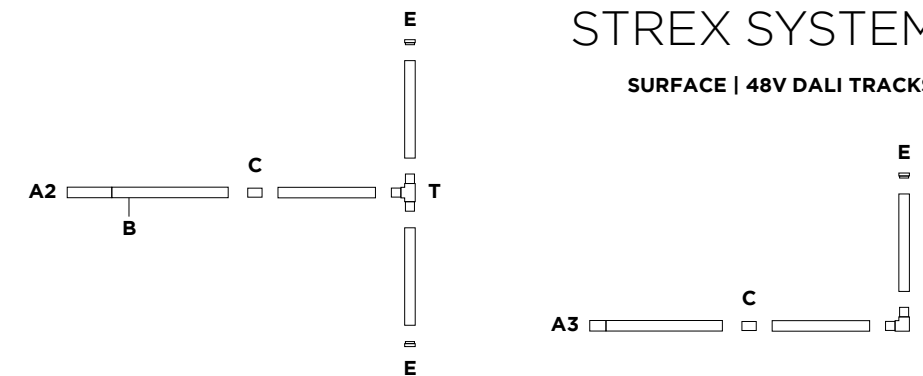

more on page 739 and weverducre.com/strex-custom

Electrical components of champagne and bronze connectors and drivers will be black.

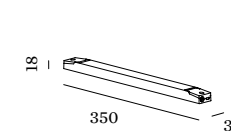

A1 | REMOTE DRIVER

220-240VAC | 50-60Hz | 48V for connection to power feed

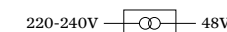

	CODE
100W 48V	90218901
150W 48V	90218902

for DALI SELV solution see page 740

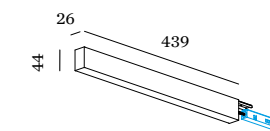

A2 | IN LINE DRIVER

220-240VAC | 50-60Hz | 48V connection to power feed | incl. DALI through wiring | housing incl. driver

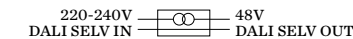

	CODE
100W	90014166
100W	90014167
150W	90014170
150W	90014171

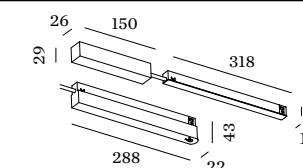

A3 | IN TRACK DRIVER

220-240VAC | 50-60Hz | 48V including power feed with in line connection box

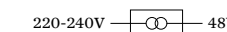

	CODE
100W	90014178
100W	90014378
100W	90014376
100W	90014176
250W	90014179
250W	90014379
250W	90014377
250W	90014177

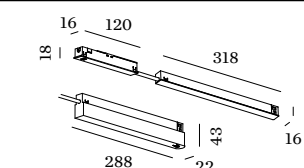

A4 | IN TRACK DRIVER

220-240VAC | 50-60Hz | 48V including power feed with in track connection

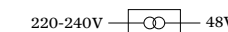

	CODE
100W	90014144
100W	90014143
250W	90014146
250W	90014145

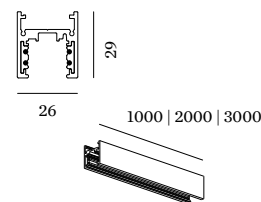

SURFACE

track 48V | 15A | DALI



	CODE
1m	90014181
1m	90014182
2m	90014183
2m	90014383
2m	90014384
2m	90014184
3m	90014185
3m	90014385
3m	90014386
3m	90014186

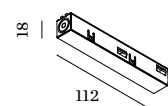

B | POWER FEED

48V | 15A | DALI | end/middle power feed | max. 4 x 1.5mm²

	CODE
	90014153
	90014154

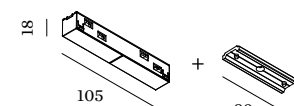

C | CONNECTOR

48V | 15A | DALI | electrical/mechanical connector

	CODE
	90014196
	90014197



E | END CAP

	CODE
	90014147
	90014347
	90014348
	90014148

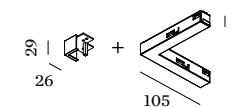

L | L-CONNECTOR

48V | 15A | DALI | electrical/mechanical connector

	CODE
	90014198
	90014398
	90014399
	90014199

for 4 corner O shape, refer to mounting instructions or online configurator

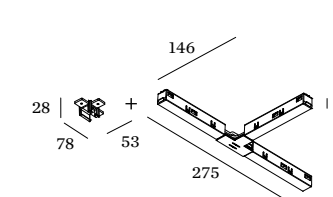

T | T-CONNECTOR

48V | 15A | DALI | electrical/mechanical connector

	CODE
	90014292
	90014293

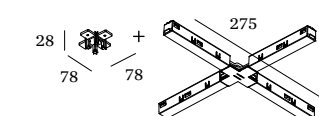

X | X-CONNECTOR

48V | 15A | DALI | electrical/mechanical connector

	CODE
	90014295
	90014294

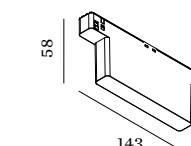

F | WIRELESS CASAMBI CONTROL

8W | adapter for wireless control of 64 fixtures in max. 8 groups

	CODE
	90014155
	90014156

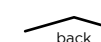

back



STREX SYSTEM

SUSPENDED | 48V DALI TRACKS

SUSPENDED EXAMPLES

configure your own STREX SYSTEM online at weverducre.com/strex-configurator

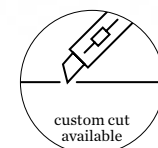
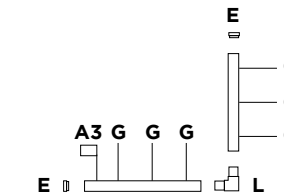
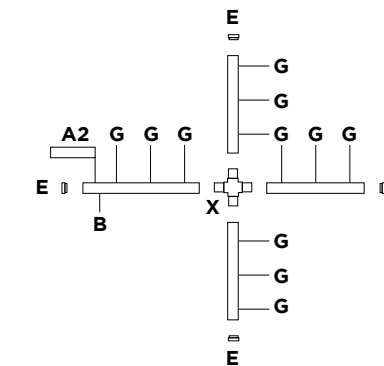
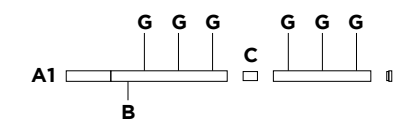

more on page 739 and weverducre.com/strex-custom

Electrical components of champagne and bronze connectors and drivers will be black.

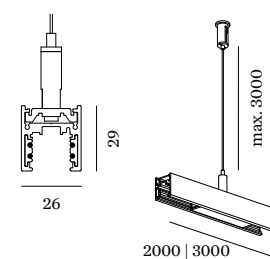
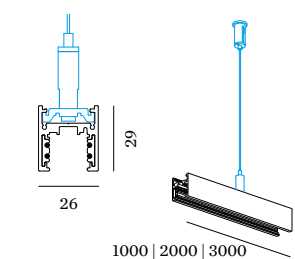

for 1m - 2pcs needed
for 2m - 3pcs needed
for 3m - 4pcs needed

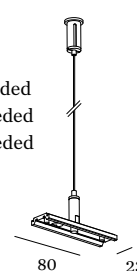

B | POWER FEED

48V | 15A | DALI | end/middle power feed | max. 4 x 1.5mm²

	CODE
	90014153
	90014154

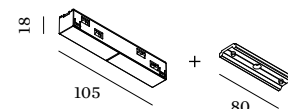

C | CONNECTOR

48V | 15A | DALI | electrical/mechanical connector

	CODE
	90014196
	90014197

SUSPENDED

track 48V | 15A | DALI

SELV

	CODE
1m	90014181
1m	90014182
2m	90014183
2m	90014383
2m	90014384
2m	90014184
3m	90014185
3m	90014385
3m	90014386
3m	90014186

SUSP. INDIRECT LIGHT

track 48V | 15A | DALI | with indirect light | 3.0m suspension sets already included | 15W/m

SELV

	CODE
3000K >90 CRI 1900lm	
2m	900140W5
2m	900140B5
3000K >90 CRI 2850lm	
3m	900141W5
3m	900141B5

G | SUSPENSION SET

complete suspension set incl. ceiling fixation bracket | not needed for indirect light version

stainless steel colour

	CODE
max. 1.5m	90014160
max. 3m	90014161

black colour

	CODE
max. 1.5m	90014274
max. 3m	90014275

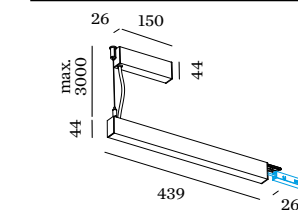

A1 | IN LINE DRIVER

220-240VAC | 50-60Hz | 48V for connection to power feed incl. DALI through wiring suspended driver in line with profile

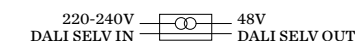

	CODE
100W	90014260
100W	90014261
150W	90014262
150W	90014263

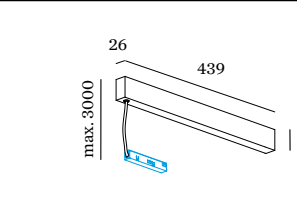

A2 | CEILING DRIVER

220-240VAC | 50-60Hz | 48V for connection to power feed incl. DALI through wiring driver ceiling mounted

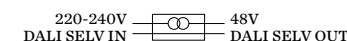

	CODE
100W	90014168
100W	90014169
150W	90014172
150W	90014173

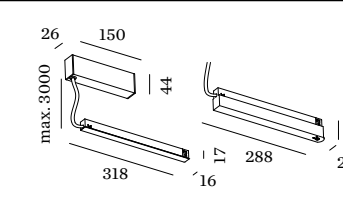

A3 | IN TRACK DRIVER

220-240VAC | 50-60Hz | 48V including power feed incl. 3m power cable suspended driver in the profile

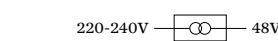

	CODE
100W	90014157
100W	90014174
250W	90014158
250W	90014175

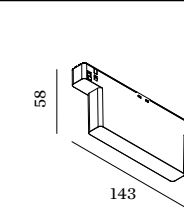

F | WIRELESS CASAMBI CONTROL

8W | adapter for wireless control of 64 fixtures in max. 8 groups

	CODE
	90014155
	90014156

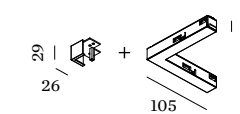

L | L-CONNECTOR

48V | 15A | DALI | electrical/mechanical connector

	CODE
	90014198
	90014398
	90014399
	90014199

for 4 corner O shape, refer to mounting instructions or online configurator

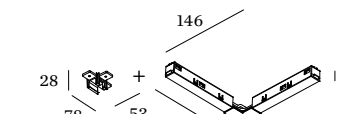

T | T-CONNECTOR

48V | 15A | DALI | electrical/mechanical connector

	CODE
	90014292
	90014293

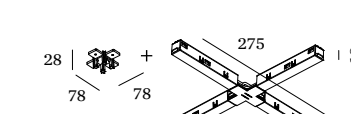

X | X-CONNECTOR

48V | 15A | DALI | electrical/mechanical connector

	CODE
	90014295
	90014294

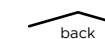

1-PHASE TRACKS

220-240V TRACKS | ACCESSORIES

RECESSED | SURFACE | SUSPENDED EXAMPLES



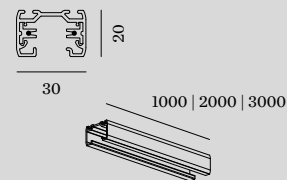
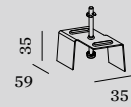
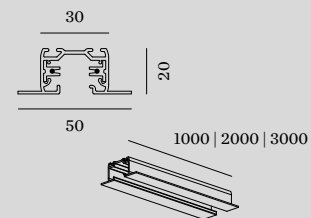
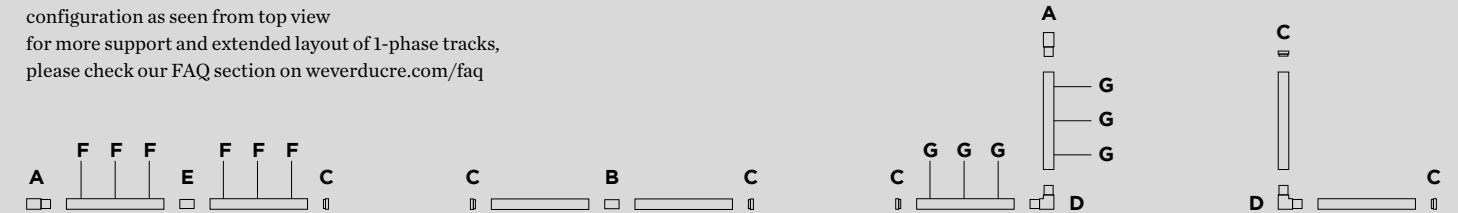



configuration as seen from top view
for more support and extended layout of 1-phase tracks,
please check our FAQ section on weverducre.com/faq



TRACK PROFILE

recessed | 220-240V | 16A



	CODE
 1m	90014118
 1m	90014119
 2m	90014120
 2m	90014121
 3m	90014122
 3m	90014123

F | MOUNTING BRACKET

for recessed fixation









	CODE
 90014100	90014100
for 1.0m - 2pcs needed for 2.0m - 3pcs needed for 3.0m - 4pcs needed	

TRACK PROFILE





surface | suspended | 220-240V | 16A



	CODE
 1m	90014001
 1m	90014007
 2m	90014002
 2m	90014008
 3m	90014003
 3m	90014009

G | SUSPENSION SET

complete suspension set
incl. ceiling fixation bracket

	CODE
 max. 1.5m	90014101
 max. 1.5m	90014102
 max. 3m	90014103
 max. 3m	90014104
for 1.0m - 2pcs needed for 2.0m - 3pcs needed for 3.0m - 4pcs needed	

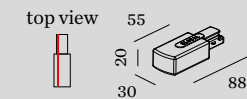

A | END FEED 1.0

220-240V | max. 3 x 1.5mm² - 16A

	CODE
 90014018	90014018
 90014019	90014019

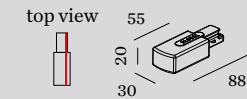

A | END FEED 2.0

220-240V | max. 3 x 1.5mm² - 16A

	CODE
 90014020	90014020
 90014021	90014021

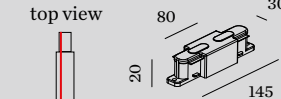

B | MIDDLE FEED

straight
220-240V | max. 3 x 1.5mm² - 16A

	CODE
 90014036	90014036
 90014037	90014037

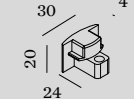

C | END CAP LEFT/RIGHT

	CODE
 90014028	90014028
 90014029	90014029



D | L-FEED 1.0

220-240V | max. 3 x 1.5mm² - 16A

	CODE
 90014024	90014024
 90014025	90014025



D | L-FEED 2.0

220-240V | max. 3 x 1.5mm² - 16A

	CODE
 90014026	90014026
 90014027	90014027



E | CONNECTOR

straight | 220-240V | 16A

	CODE
 90014022	90014022
 90014023	90014023

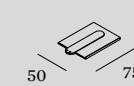

COVERPLATE END FEED

only use with recessed tracks

	CODE
 90014124	90014124
 90014125	90014125

more 1-phase track accessories on
page 752

3-PHASE TRACKS

220-240 VOLT TRACKS | ACCESSORIES

SURFACE | SUSPENDED EXAMPLES

configuration as seen from top view

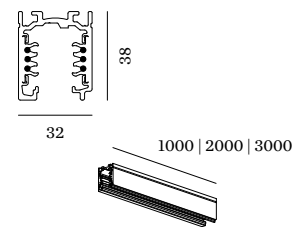
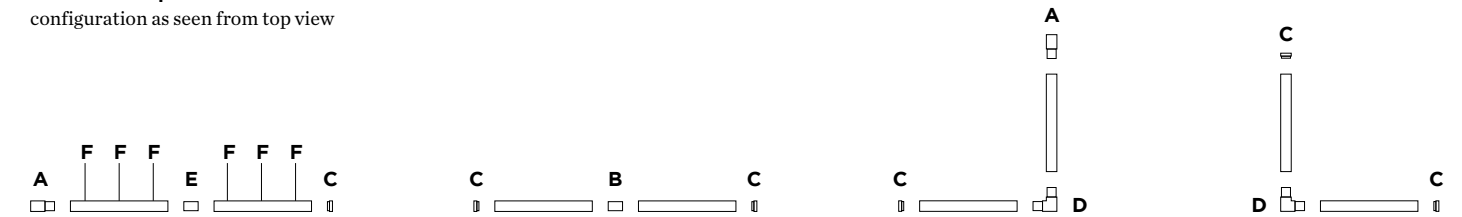

TRACK PROFILE

surface | suspended | DALI
220-240V | 16A

⊕ FELV

	CODE
1m	90014200
1m	90014201
2m	90014202
2m	90014203
3m	90014204
3m	90014205

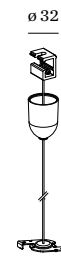

F | SUSPENSION SET

complete suspension set
incl. ceiling fixation bracket

	CODE
max. 1.5m	90014206
max. 1.5m	90014207
max. 3m	90014208
max. 3m	90014209

for 1.0m - 2pcs needed
for 2.0m - 3pcs needed
for 3.0m - 4pcs needed

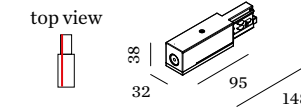

A | END FEED 1.0

including cable gasket
220-240V | max. 7 x 1.5-2.5mm² | 16A

	CODE
	90014240
	90014241

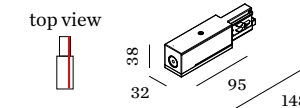

A | END FEED 2.0

including cable gasket
220-240V | max. 7 x 1.5-2.5mm² | 16A

	CODE
	90014238
	90014239

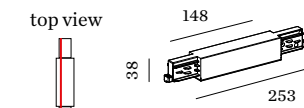

B | MIDDLE FEED

straight
220-240V | max. 7 x 1.5-2.5mm² | 16A

	CODE
	90014224
	90014225



C | END CAP LEFT/RIGHT

	CODE
	90014216
	90014217

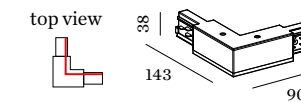

D | L-FEED 1.0

220-240V | max. 7 x 1.5-2.5mm² | 16A

	CODE
	90014220
	90014221

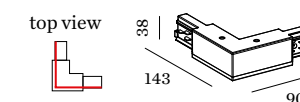

D | L-FEED 2.0

220-240V | max. 7 x 1.5-2.5mm² | 16A

	CODE
	90014222
	90014223

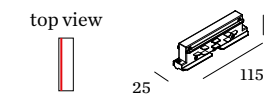

E | STRAIGHT CONNECTOR

straight | 220-240V | 16A

	CODE
	90014226
	90014227

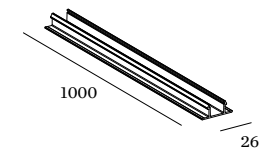

TRACK COVER

	CODE
1m	90014236
1m	90014237

more 3-phase track accessories on
page 753